

Product Features

Wide Input Voltage Range: 4:1

- ◆ Efficiency up to **90%**
- ◆ Low No-load Power Consumption
- ◆ Operating temperature range: **-40°C to +105°C**
- ◆ High insulation voltage: Input-to-output **1500VDC**, Input-to-case **1500VDC**
- ◆ Input Undervoltage Protection (UVP); Output Over-current Protection (OCP), Overvoltage, Overtemperature, and Short-circuit Protection (SCP)
- ◆ Standard **1/2-brick** form factor

The **ZBD300-24S28A** Series is a high-performance half-brick DC/DC power module. It provides a 300W regulated single output (28V) from a wide 9-36VDC input range. The series features no minimum load requirement, high isolation voltage, and an operating temperature of up to 105°C. Comprehensive protections include Input Under-Voltage (UVLO), Output Over-Current (OCP), Over-Voltage (OVP), Over-Temperature (OTP), and Short-Circuit Protection. Additional features include Remote Control (CNT), Remote Sense, and Output Voltage Trim.

Selection Guide							
Part No.	Input Range (VDC)	Output Power (W)	Output Voltage (VDC)	Output Current (A)	Ripple & Noise (mV)	Full Load Efficiency (%) Min/Typ.)	Remarks
ZBD300-24S28AC	9-36	300	28	10.7	280	88/90	Standard Positive Logic
ZBD300-24S28AN							Standard Negative Logic
ZBD300-24S28AC-H							Heat Sink Positive Logic
ZBD300-24S28AN-H							Heat Sink Negative Logic

Note: Output power is linearly derated at **9-18V** input; maximum output power is **200W** at **9V** input.

Input Characteristics							
Item	Operating Conditions	Min.	Typ.	Max.	Unit		
Max. Input Current	9V input voltage, output at full load	--	--	28	A		
No-load Input Current	Rated Input Voltage	--	--	30	mA		
Input Transient Voltage (1 sec. max.)	Input exceeding this range may cause permanent damage	-0.7	--	60	VDC		
Start-up voltage		--	--	10			
Input Undervoltage Protection (UVP)	No-load test; full-load test triggers overcurrent protection early	--	--	9			
Remote Control Pin (CNT)	Positive logic: CNT left floating or connected to 3.5-15V powers on; connected to 0-1.2V powers off Negative Logic: CNT left floating or connected to 3.5-15V powers down; connected to 0-1.2V powers up					Reference Voltage - VIN	

Output Characteristics					
Item	Operating Conditions	Min.	Typ.	Max.	Unit
Output Voltage Accuracy	Nominal Input Voltage, 0%-100% load	--	±0.5	±1.0	%
Line Regulation	Full load, input voltage from low voltage to high voltage	--	±0.2	±0.5	
Load Regulation	Nominal Input Voltage, from 10% to 100% load	--	±0.2	±0.5	
Start-up delay	Time for rated 24V input to reach 90% output	100	--	300	mS
Transient Recovery Time	25% Load Step Change (1A/50μs slew rate)	--	200	250	μs
Transient Response Deviation		-5	--	5	%
Temperature Coefficient	Full load	-0.02	--	+0.02	%/°C
Ripple & Noise	20MHz bandwidth, 220μF capacitor min.	--	200	280	mVp-p
Output voltage adjustable (TRIM)		-20	--	+10	%
Output voltage Remote Sense		--	--	5	%
OTP	Case Operating Temp. (Max.)	105	115	125	°C
OVP		125	--	140	%
OCP		11.5	--	15.5	A
SCP		Hiccup, continuous, self-recovery			

General Characteristics						
Item	Operating Conditions		Min.	Typ.	Max.	Unit
Isolation Voltage	Input-Output	Test time 1 minute, leakage current less than 3mA	--	--	1500	VDC
	Input-to-case	Test duration: 1 minute, leakage current less than 3mA	--	--	1500	VDC
	Output-to-case	Test duration: 1 minute, leakage current less than 3mA	--	--	500	VDC
Insulation Resistance	Input-Output	Insulation Voltage 500VDC	100	--	--	MΩ
Switching Frequency			--	460	--	KHz
MTBF			150	--	--	K hours

Environmental Characteristics					
Project	Operating Conditions	Min.	Typ.	Max.	Unit
Operating Temperature	See Derating Curve	-40	--	+105	°C
Storage Humidity	Non-condensing	5	--	95	%RH
Storage Temperature		-40	--	+125	°C
Lead Soldering	1.5mm from case, < 10s	--	--	+350	
Cooling Requirements		EN60068-2-1			
Dry Heat Requirements		EN60068-2-2			
Humidity Requirements		EN60068-2-30			
Shock and Vibration		IEC/EN 61373 Vehicle Body Class 1B			

EMC Characteristics (EN55032)						
Item	Standard	Frequency	Level	Distance	Criteria	
EMI	CE	EN55032-3-2	150kHz-500kHz	66dBuV		
		EN55032-2-1	500kHz-30MHz	60dBuV		
	RE	EN55032-3-2	30 MHz-230 MHz	50 dBuV/m	at 3 m	
		EN55032-2-1	230MHz-1GHz	57dBuV/m	at 3m	
EMS	ESD	IEC/EN 61000-4-2	Contact ±6KV/Air ±8KV		Perf. Criteria B	

Radiated Immunity	IEC/EN 61000-4-3	10V/m	Perf. Criteria A
EFT	IEC/EN 61000-4-4	±2kV 5/50ns 5kHz	Perf. Criteria A
Surge Immunity	IEC/EN 61000-4-5	Line to line ± 2kV	Perf. Criteria B
CS	IEC/EN 61000-4-6	10 Vr.m.s	Perf. Criteria A

Physical Characteristics	
Case Material	Metal base + black flame-retardant material housing (UL94-V0)
Heat Sink	Dimensions: 61*57.9*15mm, Weight: 72g, Aluminum alloy material, Black anodized finish
Cooling Method	Conduction or forced air
Total Weight	Standard model: 115g, Heat Sink model: 188g

Structural Dimensions and Pin Definitions

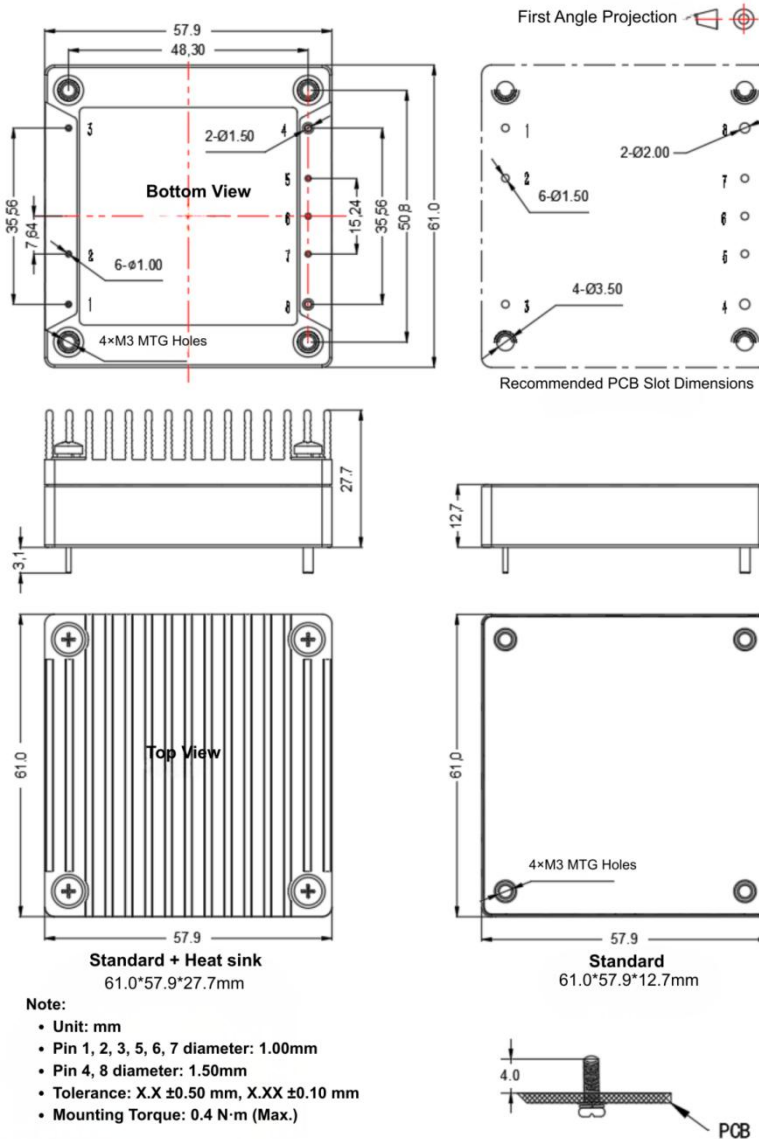

Pin No.	1	2	3	4	5	6	7	8
Pin Symbol	Vin+	CNT	Vin-	Vout-	-S	TRIM	+S	Vout+
Description	Positive Input	Remote Control	Negative Input	Negative Output	Remote Sense Negative	Output Voltage Trim	Remote Sense Positive	Positive Output

Product Characteristic Curves

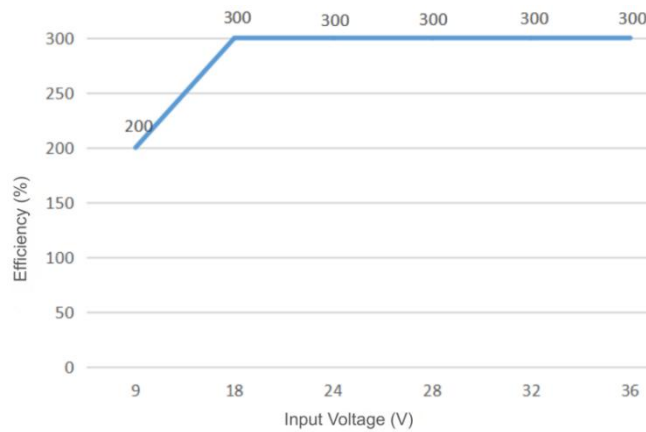
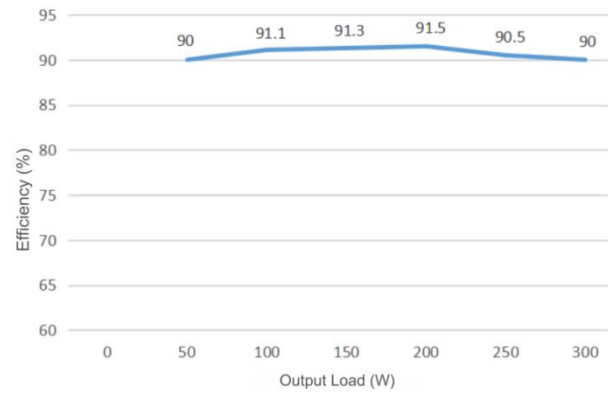
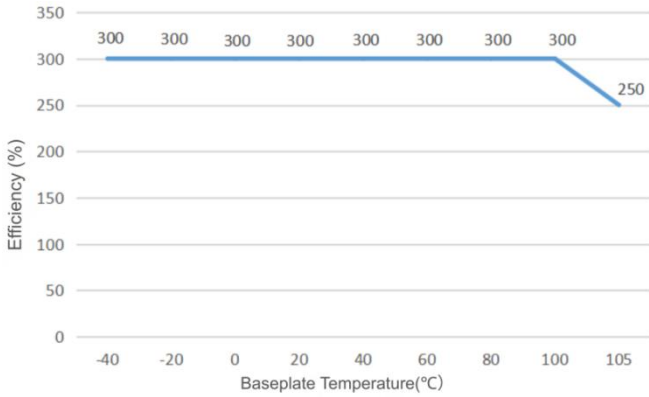

Note:

- Both the thermal derating curves and efficiency curves are based on typical test values.
- The thermal derating curves are obtained under our laboratory test conditions. If the actual application environment differs, please ensure that the aluminum case temperature of the product does not exceed 100°C. The product can be used within any rated load range as long as this temperature limit is maintained.

Design Reference

1. Ripple & Noise

All DC/DC converters in this series are tested prior to shipment using the recommended test circuit shown below.

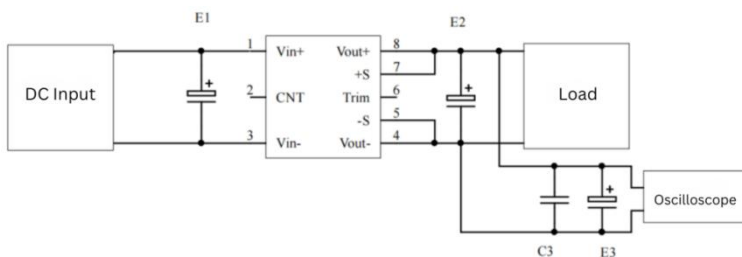

Output Volt	Cap. Value	E1 (μF)	E2 (μF)	C1 (μF)	E3 (μF)
3.3VDC		100	1000	1	10
5VDC			680		
12VDC			220		
.....		68	68		
48VDC					
110VDC					

2. Recommended Application Circuit

If the customer does not use our recommended circuit, a minimum 100 μF electrolytic capacitor must be connected in parallel at the input to suppress potential surge voltages.

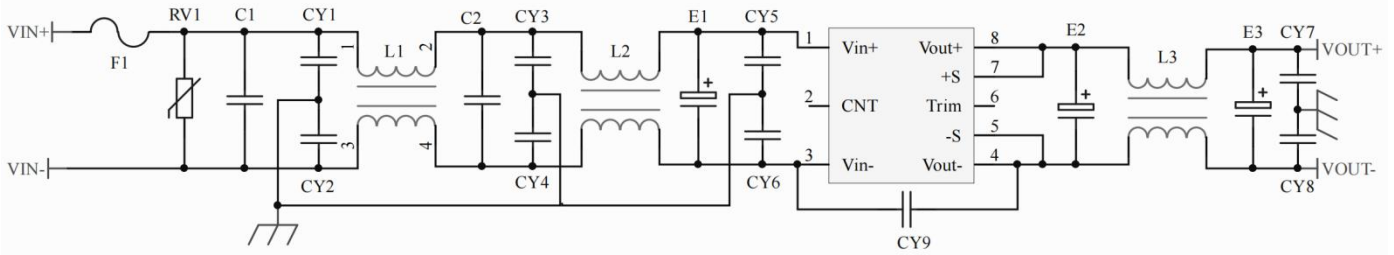

F1	T40A/63V fuse
RV1	14D 62V MOV
C1, C2	105/100V Polyester Film Capacitor
CY1, CY2, CY3, CY4, CY5, CY6	102/250Vac Safety Y2 Capacitor
CY7, CY8	103/2KV Ceramic Capacitor
CY9	471/250Vac Safety Y2 Capacitor
E1	470μF/63V Electrolytic Capacitor
E2, E3	470μF/35V Electrolytic Capacitor
L1, L2	Inductance greater than 3mH, overcurrent 28A, temperature rise less than 25°C
L3	Inductance greater than 100uH, overcurrent 11A, temperature rise less than 25°C

3. Recommended Application for Remote Control (CNT) Control Method

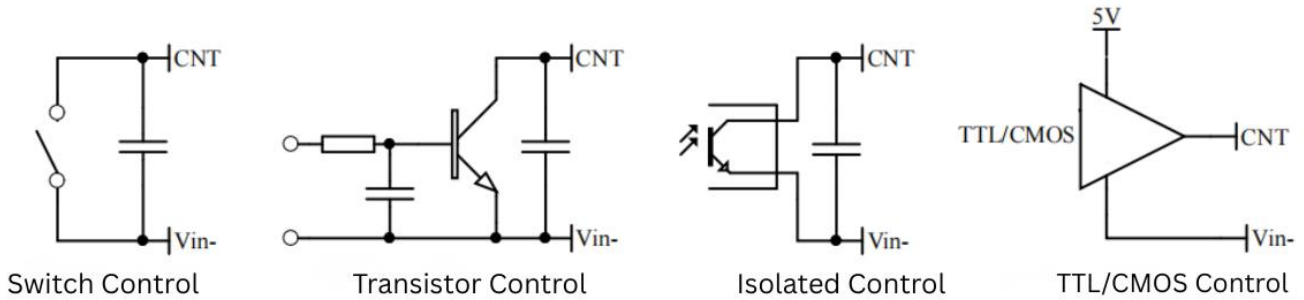

4. Sense Usage and Precautions

(1) When not using Remote

Sense:

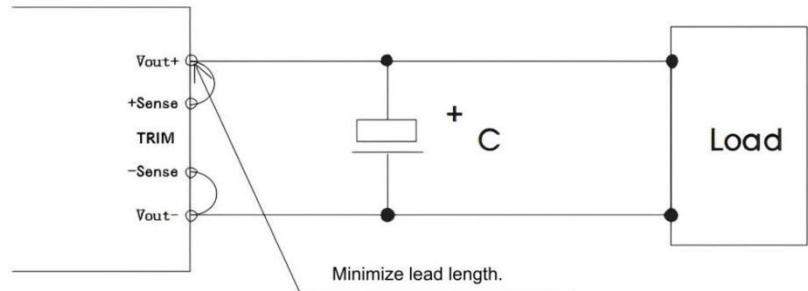

Precautions:

1. If Remote Sense is not used, **+Vout** must be shorted to **+Sense**, and **-Vout** to **-Sense**.
2. Keep the connections between **Vout** and **Sense** as short as possible and close to the pins to ensure module stability

(2) Using Remote Sense:

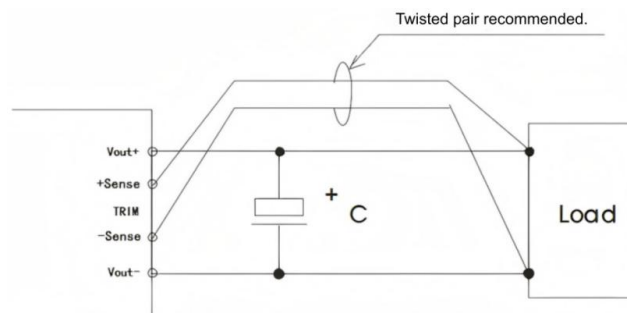

Precautions:

1. Long Remote Sense leads may cause output voltage instability;
2. If Remote Sense is used, employ twisted-pair or shielded cables and keep the leads as short as possible;
3. Use wide PCB traces or thick wires between the power module and load, ensuring line voltage drop remains below 0.3V to maintain output voltage within specified limits;
4. Lead impedance may cause output voltage oscillation or significant ripple; verify Perf. before use.

5. TRIM Usage and TRIM Resistor Calculation

The relationship between output voltage variation ΔU and resistance is as follows:

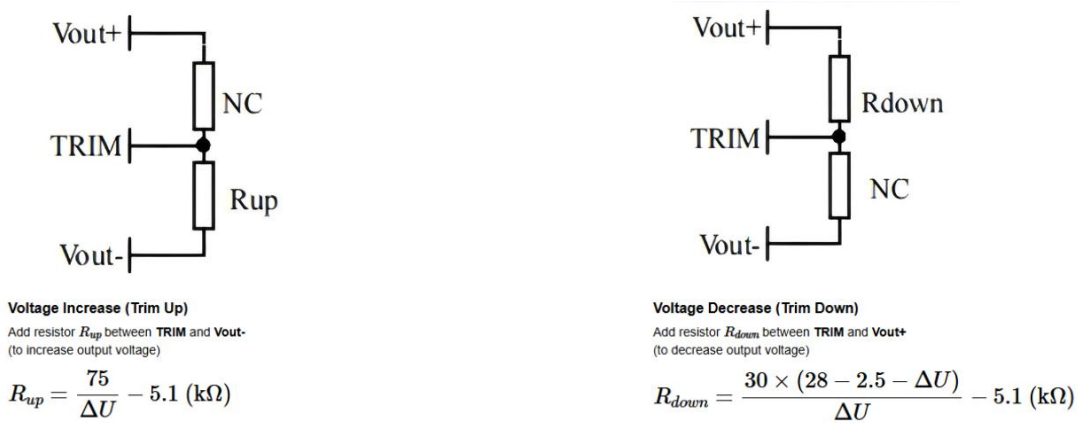

6. This product does not support direct parallel operation for power boosting. For parallel usage, please consult our technical personnel.

Additional Information

1. Warranty: This product has a 2-year warranty. We provide free repairs for any damage occurring under normal use. Paid maintenance is available for damage caused by improper use or unauthorized modifications.
2. Customization: We offer customized products and matching filter modules. Please contact our technical support team for details.
3. Updated: 2026-03-05

Guangzhou Aipu Electron Technology Co., Ltd

Address: Building 4, HEDY Park, No.63, Punan Road, Huangpu Dist, Guangzhou, China.

Tel: 86-20-84206763 Fax: 86-20-84206762 HOTLINE: 400-889-8821

E-mail: sales@aipu-elec.com Website: <https://www.aipupower.com>